

TROUBLESHOOTING

Before contacting a dealer or qualified service technician, please read and check the following:

PROBLEM

Unit does not turn on.

SOLUTION

1. Make sure city power supply is normal.
2. Check plug is correctly installed into outlet.
3. Check fuses and household breaker switches.
4. Remove electrical plug from outlet. Check electrical cord and plug for damage.
5. Check to be sure water tank is installed properly into unit.
6. Check that plug is secure and in place on condensate tube.
7. Check louvers and grills for obstacles or debris.
8. Check room temperature. Room temperature should not be below 60°F (15°C) or above 95°F (35°C).
9. Compressor delay feature may be active. Unplug unit and wait for 3-5 minutes. Plug unit into outlet and press "POWER ON/OFF" switch.

Unit running low air flow or cooling.

1. Check and clean air filter.
2. Check louvers and grills for obstacles or debris.
3. Check MODE and/or THERMO CONTROL selection and adjust for higher air output. (See "OPERATION.")
4. Allow unit to stand upright for a minimum of two hours before attempting to operate.

Unit noisy when operating.

1. Check that unit is on a flat, level, solid surface.
2. Check filter and tank are installed properly.
3. Turn unit off. Check louvers and grills for obstructions.
4. Allow unit to stand upright for a minimum of two hours before attempting to operate.

Water leaking from unit.

1. Check that unit is on a flat, level, solid surface.
2. Check that plug is secure and in place on condensate tube.

Freecom[®]

Models

RCS-M2000T
RCS-M2000U

PORTABLE AIR CONDITIONER

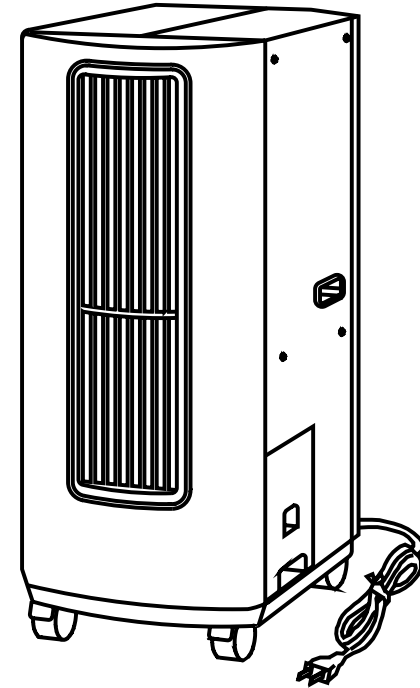

OPERATION MANUAL

IMPORTANT NOTICE:

To avoid damage and voiding your warranty, place the unit in its upright position for a minimum of two hours before operating.

For best results, and more enjoyment from your new FREECOM portable air conditioning unit, please read this instruction manual carefully and save for future reference.

TABLE OF CONTENTS

Owner's Record	2
Features	3
Accessories	3
Important Safety Information	4-5
Product Parts	6
The Control Panel	7
Specifications	8
Before Using	8
Operation	9
Accessory Installation	10
Exhaust Duct Kit	10
Window Panel Kit	11
Maintenance and Cleaning	12
Emptying Condensate Water Tank	12
Cleaning Air Filter	13
Cleaning Cabinet Exterior	14
Storage	15
Troubleshooting	16

WARNING:

TO REDUCE THE RISK OF FIRE OR ELECTRIC SHOCK, DO NOT EXPOSE THE UNIT TO RAIN OR MOISTURE.

DO NOT OPEN CABINET. DANGEROUS HIGH VOLTAGE IS PRESENT. REFER SERVICING ONLY TO QUALIFIED PERSONNEL.

Your air conditioner contains a refrigerant which is converted from a gas to a liquid by a highly efficient compressor. It has been designed to operate in a vertical position only. Should it be necessary to lay the unit on its side, place it in its upright position for a minimum of two hours before restarting or operating the unit. This time period permits the liquids, gases and oils contained within the sealed systems to return to their proper positions.

OWNER'S RECORD

Enter product information here for future use:

Date of Purchase _____

Dealer _____

Model No. _____

Serial No. _____

STORAGE

NOTE: Optional storage cover available for model M2000T/U (Part # RRG9723-55-1). For information about ordering a storage cover, consult your Freecom Dealer.

1. Press "POWER ON/OFF" button to stop unit if it is operating. Unplug power cord from outlet.

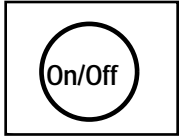

2. Remove and empty condensate water tank. See "Emptying Condensate Water Tank" under "MAINTENANCE AND CLEANING."

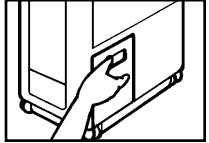

3. Remove plug from condensate tube (inside water tank compartment) and drain water. Replace plug tightly onto end of tube.

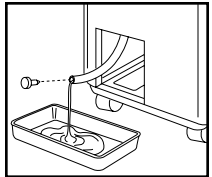

4. For long-term storage, turn the unit on to "FAN" mode and allow the unit to run for 3-4 hours. This will dry the inside of the unit.

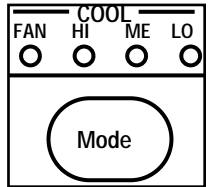

5. Carefully wrap power cord and secure with cord wrap on back of unit.

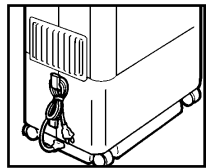

6. Store unit in its UPRIGHT POSITION in a cool, dry indoor location. If possible, store unit in its original box. DO NOT store unit in direct sunlight.

MAINTENANCE AND CLEANING (contd.)

Cleaning Cabinet Exterior

⚠ WARNING: ELECTRICAL SHOCK HAZARD:

- Turn off unit and unplug from wall outlet before cleaning.
- Never submerge the unit in any type of liquid or expose to heavy moisture.
- Never spray, pour, or sponge water directly onto the unit .
- Never use brushes, brooms, harsh detergents, chemicals, solvents, gasoline, or any other abrasive materials or household items to clean the unit.
- Remove excess moisture from cabinet and grill areas, and make sure unit, filters, and tank are completely dry before installation/operation.

1. Press "POWER ON/OFF" button to stop unit if it is operating. Unplug power cord from outlet.

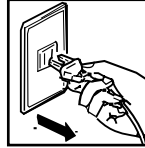

2. Wipe cabinet exterior with a soft cloth dampened with warm water (not to exceed 100°) and a mild detergent. Use a dry cloth to completely dry cabinet exterior.

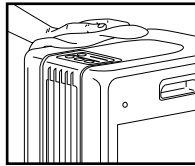

3. Remove loose debris and lint from air intake grills by using a soft brush vacuum attachment. Carefully vacuum both intake grills (located on the left side and rear of unit).

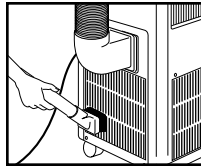

FEATURES

Thank you for purchasing the FREECOM RCS-M2000 Portable Air Conditioner. The RCS-M2000 series Portable Air Conditioner is designed with many state-of-the art features:

- Quiet, durable caster wheels allow for easy movement and instant spot cooling in any room.
- Convenient, electronic operation panel enables one-touch control of all functions.
- Provides clean, fresh, air conditioned, dehumidified air.
- Automatic, oscillating louvers provides air distribution over a wide area .
- Low-noise, rotary compressor cools from air-to-air—no water required.
- Attractive design and easy-to-clean exterior cabinet.

ACCESSORIES

The FREECOM RCS-M2000 Portable Air Conditioner offers a wide range of accessories to customize your installation.

- Exhaust Duct Kit (provided) increases cooling efficiency by directing warm air exhaust from room to be cooled.
- Window Panel Vent Kit (two sizes available; special order only) prevents outside air from entering the room when used with the Exhaust Ducting Kit.
- Sliding Door Vent Kit (special order only) allows exhaust air to be directed out a sliding door while preventing outside air from entering room when used with the Exhaust Ducting Kit.
- Window Snap Lock Kit (special order only) aids in maintaining proper window opening when using Window Panel Vent Kit.
- Ceiling Panel Kit (special order only) replaces a standard 2-foot dropped ceiling panel for warm air exhaust.
- Through-the-Wall Kit (special order only) can be installed into the wall for warm air exhaust.
- Tank Microswitch Bypass Plate (special order only) can be installed to bypass the condensate water tank. This accessory can be used to drain condensate water to a field-installed drain pipe.
- Sub Water Tank Attachment (special order only) allows for added condensate water holding capacity when it is attached to the main water tank.

TRES IMPORTANT

Pour éviter les risques d'incendie ou de choc électrique, n'exposez pas l'appareil à la pluie ou à l'humidité.

En cas de panne, faites appel au service après-vente qualifié pour effectuer des réparations sur cet appareil.

Votre climatiseur contient un réfrigérant qui passe d'une phase gazeuse à une phase liquide au moyen d'un compresseur. Il doit être utilisé en position verticale. Si pour une raison quelconque vous deviez le coucher sur le côté, ne le remettez en route que deux heures environ après l'avoir replacé en position verticale. Ceci permettra le repositionnement correct des liquides et gaz du système réfrigérant.

INSTRUCTIONS DE SECURITE

A lire attentivement avant utilisation

Sécurité

- Ne pas arrêter l'appareil en débranchant la prise de courant en cours de fonctionnement. Ceci pourrait endommager le circuit de contrôle (dommage exclu de la garantie). Utilisez toujours le bouton "ON/OFF" du tableau de commande.
- Ne pas glisser le cordon d'alimentation sous la moquette ou des tapis.
- Ne pas recouvrir l'appareil avec des vêtements, serviettes ou objets similaires.
- Ne pas obstruer l'entrée ou la sortie d'air, ni bloquer les déflecteurs oscillants.
- Ne pas débrancher l'appareil si vos mains sont humides : il y a risque de choc électrique.
- Ne pas placer d'objets sur le dessus de l'appareil.

Positionnement

- Ne pas coucher l'appareil sur les côtés : il doit être maintenu en position verticale.
- Ne pas placer l'appareil près d'une source de chaleur, ou l'exposer directement aux rayons du soleil. Protéger la pièce de l'exposition directe du soleil en fermant rideaux et stores, etc...pour améliorer le rafraîchissement.
- Ne pas placer l'appareil près de rideaux qui risquent de bloquer l'entrée ou la sortie d'air (distance minimale: 50 cm).
- Vérifier que l'appareil est placé sur une surface plane.

Utilisation

- Ne pas transporter l'appareil en fonctionnement.
- Ne pas essayer de modifier ou de réparer vous-même l'appareil : ceci peut être dangereux et annulera la garantie.
- Ne pas utiliser l'appareil sans filtre à air.

MAINTENANCE AND CLEANING (contd.)

Cleaning Air Filter

This unit has one air filter. For best results and maximum performance, clean filter every two weeks, or as required by environmental conditions.

⚠ CAUTION: Neglect or failure to regularly clean the filter will result in poor efficiency, reduced performance, possible damage to the unit, and voiding your warranty.

1. Press "POWER ON/OFF" button to stop unit if it is operating. Unplug power cord from outlet.

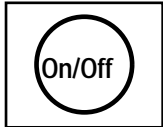

2. Locate filter pull tab on side of unit (closest to "POWER ON/OFF" button). Carefully pull filter from side of unit.

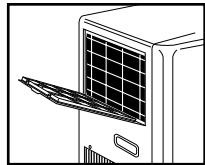

3. Place air filter on a flat, level surface so "dirty" side of filter faces up. Using a brush or nozzle vacuum attachment, gently vacuum "dirty" side of filter. Turn filter over and vacuum other side. Use care not to damage or puncture the filter mesh. DO NOT use brushes, brooms, or other coarse materials to clean the filters.

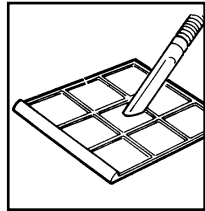

4. Hold air filter, "dirty" side down, under cool, running water. DO NOT use hot water, harsh detergents, chemicals, solvents, gasoline or any other abrasive materials or household items to clean the filters. Be sure to rinse all residue from the air filter mesh. Carefully shake air filter to remove excess water. Allow air filter to dry completely before reinstalling into unit.

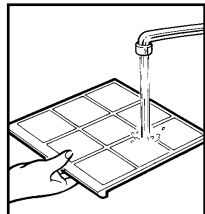

⚠ WARNING: Forcing filter improperly into unit may cause damage to the filter section of the cabinet. Repair due to improper filter installation is not covered under warranty.

5. Align tabs on bottom of filter with square holes in filter opening on side of cabinet. Carefully replace filter. Filter will "snap" into place.

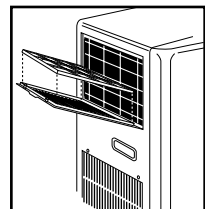

CAUTION: DO NOT operate the unit without the air filter properly installed.

MAINTENANCE AND CLEANING

Emptying Condensate Water Tank

When the condensate water tank is full, the “FULL TANK” indicator light will flash, the unit will sound several initial warning beeps, and the unit will automatically turn off.

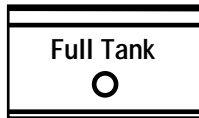

NOTE: If emptying water tank before “full tank” alert, press “POWER ON/OFF” button to stop unit if it is operating.

1. Unplug power cord from outlet. Allow unit to remain off for 3-5 minutes.

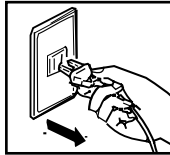

2. Grasp the condensate water tank handle opening and carefully pull water tank straight out of unit.

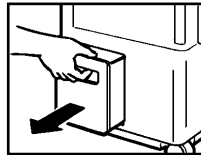

3. Carefully carry the tank to a sink or tub and empty its contents. Use water and a mild detergent to rinse and clean the inside and outside of the tank. Dry tank completely and be sure tank is completely empty.

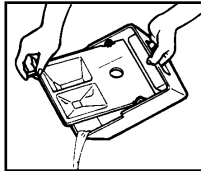

4. Hold water tank by handle and carefully push tank straight into opening in side of unit. Push in until tank is flush with housing.

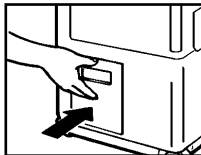

5. Plug power cord into outlet. Press “POWER ON/OFF” button. If the condensate water tank is improperly installed, the FULL TANK indicator light will flash, several initial warning beeps will sound, and the unit will not turn on. Double check that water tank is properly installed. Press “POWER ON/OFF” button again to start unit.



IMPORTANT SAFETY INFORMATION

PLEASE READ AND FOLLOW ALL SAFETY INFORMATION AND INSTRUCTIONS BEFORE OPERATING YOUR NEW FREECOM AIR CONDITIONER.

WARNING:

ELECTRICAL SHOCK HAZARD. Failure to follow the safety information below can result in severe personal injury or property damage.

- Use this product only with the proper electrical voltage. (See “Specifications.”)
- DO NOT use the electrical plug to start or stop the unit. Doing so could cause damage to the control circuit and invalidate the warranty. Use only the POWER ON/OFF button on control panel to turn the unit on or off. Avoid pulling, folding, or stretching the electrical cord. When plugging in the unit, never touch or bend the metal prongs and always use the molded plug handle.
- DO NOT plug this appliance into an outlet that is being used by other appliances or electrical devices. An overloaded electrical circuit or outlet may result in fire and/or injury from electrical shock and damage to the product. If the outlet or electrical circuit becomes warm or hot and/or the designated fuse or breaker switch trips or fails, this may be an indication of an electrical overload. Turn off the air conditioner immediately using the POWER ON/OFF button on the control panel and contact a qualified electrician to determine the problem.
- DO NOT run power cord under carpeting or rugs as this may result in fire.
- DO NOT plug in or unplug the power cord with wet hands.
- DO NOT expose unit to water or moisture.
- DO NOT use outdoors.

CAUTION:

Failure to follow the safety information below can result in minor personal injury, property damage, damage to the unit, and voiding your warranty.

- DO NOT cover the unit with clothes, towels, blanket, or other similar materials.
- DO NOT block or cover air intake, exhaust, or oscillating louvers.
- DO NOT touch oscillating louvers or blower while the unit is operating.
- DO NOT attempt to carry the unit or roll the unit over carpet, rough, or uneven surfaces.
- DO NOT operate the unit without the condensate tank and air filters properly installed.
- Never use the unit as a dryer or put clothes or any other items on the unit.
- Never place air conditioner near flammable materials.
- Never put heavy objects on the unit.
- To avoid damage and maintain proper operation, place the unit a minimum of 20 inches from walls, curtains, furniture, blankets, loose material, or any other obstructions. Keep the unit a safe distance from stairs.
- DO NOT use or operate the product in a confined space, such as a closet.
- To avoid water leakage and damage:
 - Always operate the product on a solid, level surface.
 - Before moving the unit, always turn it off using the POWER ON/OFF button on the control panel and empty the condensate tank. Allow the unit to stand at least five (5) minutes.
 - DO NOT drop the unit or place it on its sides, back, top or front. Always keep the unit in its upright position.
- To reduce the possibility of illness from excessive cooling: avoid direct, continuous exposure and never place the unit in a closed space occupied by persons incapable of operating the product properly.

PRODUCT PARTS

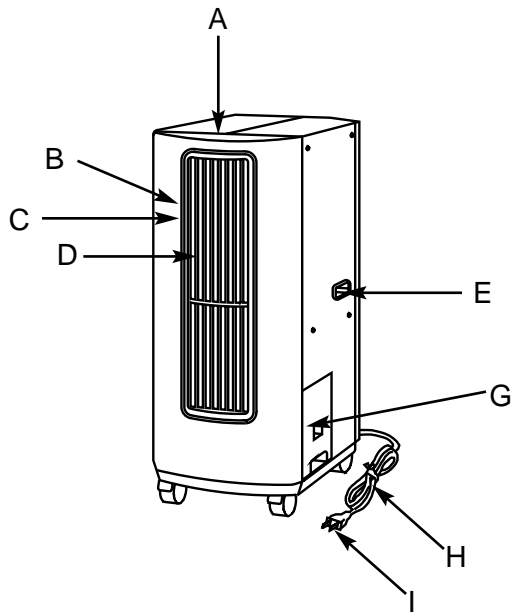

REAR VIEW

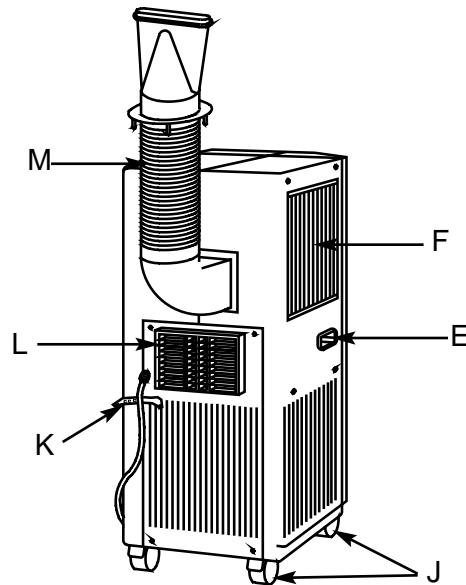

FRONT VIEW

- A. Control Panel
- B. Horizontal Air Louver (up and down)
- C. Air Outlet
- D. Vertical Air Louver (left to right)
- E. Built-in Handle
- F. Air Filter
- G. Condensate Water Tank
- H. Power Cord
- I. Plug
- J. Caster Wheels
- K. Power Cord Wrap
- L. Exhaust Vent and Duct Hose Opening
- M. Exhaust Ducting Kit

ACCESSORY INSTALLATION

Window Panel Kit (Optional Accessory)

The Window Panel Kit is an accessory which, when used with the Exhaust Duct Kit, will increase cooling efficiency by directing warm air exhaust out a window and preventing outside air from getting into the room.

1. Extend panels to fit in window opening. For vertical windows, be sure cut-out is to the bottom.

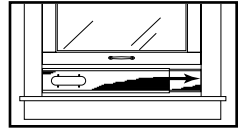

2. To secure panels in place, install set screws into two smaller holes on outer panel.

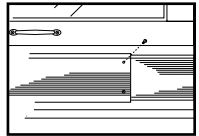

3. Locate two long, rubber weather strips. Hold flat side of weather strips along outside of outer panel (with cutout). Slide weather strips into rails on each side of outer panel.

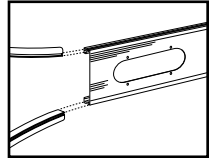

4. Locate two short, rubber weather strips. Hold flat side of weather strips along outside of inner panel. Slide weather strips into rails on each side of inner panel.

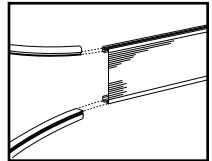

5. Cut the two short, rubber weather strips to align with end of inner panel. Use care when cutting weather strips.

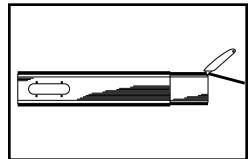

6. Place Window Panel Kit into window opening. Close window tightly against Window Panel Kit.

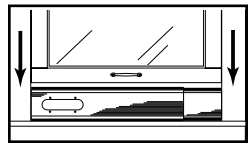

7. Install the outlet nozzle of the Exhaust Duct Kit into the cut-out in the outer panel. The outlet nozzle fits tightly into the cut-out.

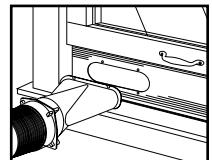

OPERATION (contd.)

6. Press "AUTO SWING" button on control panel to begin oscillating vertical louvers. The vertical louvers will move slowly from left to right and back again for optimum air distribution. Press button again to maintain a desired "fixed" position to distribute more cooling air to one side of the room. **DO NOT** adjust vertical louvers manually.

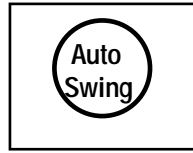

7. If desired, press "TIMER-SET" button on control panel to program the air conditioning unit to turn off in 1, 2, 3, 4, 5, 6, 7, 8, or 9 hours.

To cancel timer setting, press "TIMER-RESET" button.

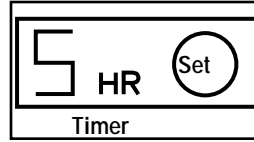

ACCESSORY INSTALLATION

Exhaust Duct Kit

The Exhaust Duct Kit is an accessory which, when used with the RCS-M2000 series air conditioning units, will increase cooling efficiency by directing warm air exhaust out of the room. The Exhaust Duct Kit can be used with other Freecom accessories, such as the Window Panel Vent Kit (included), Sliding Door Vent Kit, Ceiling Vent Kit, or Through-the-Wall Kit for maximum cooling efficiency.

⚠ WARNING: The Freecom Exhaust Duct Kit has been specially designed for use with the RCS-M2000 series air conditioning units. Using other duct materials, components, or extensions will decrease cooling efficiency or cause damage to the product, and void your warranty.

1. Press "POWER ON/OFF" button to stop unit if it is operating. Unplug power cord from outlet.
2. Slide square end of bent exhaust duct kit over exhaust on rear of unit. Push nozzle onto round connector end of vent duct pipe.

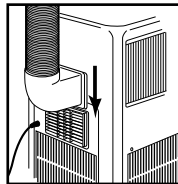
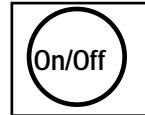

3. Install outlet nozzle in an open window, through a wall or false ceiling.

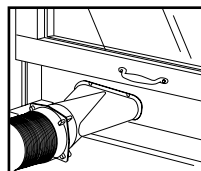

THE CONTROL PANEL

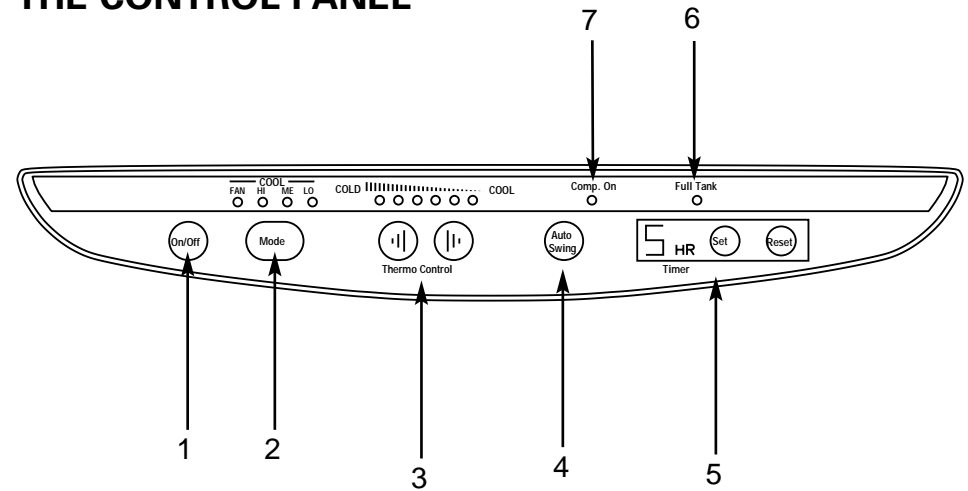

1. **POWER ON/OFF**
Easy push-button control switch to turn the unit ON and OFF.
2. **MODE**
There are four different fan speed settings:
 - FAN—Fan only (no cooling)
 - HI—High fan speed with cooling setting
 - ME—Medium fan speed with cooling setting
 - LO—Low fan speed with cooling setting.
3. **THERMO CONTROL**
The Thermo Control automatically defaults to a temperature of approximately 75°F when the unit is started. Adjust left button for colder air and right button for warmer air. Each press of either button adjusts the temperature control by approximately 3.5°F.
4. **AUTO SWING**
Choose between fixed position or oscillating (70 degrees) vertical louvers.
5. **TIMER**
Adjustable 9 hour timer can be programmed to turn off air conditioner after 1, 2, 3, 4, 5, 6, 7, 8, or 9 hours.
6. **FULL TANK INDICATOR**
The full tank indicator will automatically light and 8 "beeps" will sound when the water tank is full.
7. **COMPRESSOR "ON" INDICATOR**
The "COMP. ON" light will turn on when the compressor is operating. The light will turn off when the compressor stops. This unit is equipped with a special safety time delay feature. The compressor (cooling mechanism) may be delayed for up to five minutes. This safety feature prevents damage to the compressor.

SPECIFICATIONS

Model	Power/Electrical Requirements	Cooling Capacity	Input	EER
RCS-M2000T	110/115 volt, 60Hz	8000 BTU/h (2300W)	800W	10
RCS-M2000U	230 volt, 50Hz	7500 BTU/h (2300W)	660W	N/A
RCS-M2000B	220/240 volt, 60Hz	8000 BTU/h (2300W)	800W	N/A

BEFORE USING

IMPORTANT: Remove unit from packaging and discard clear, plastic wrapping. Place unit in its upright position for a minimum of three hours before operating for the first time.

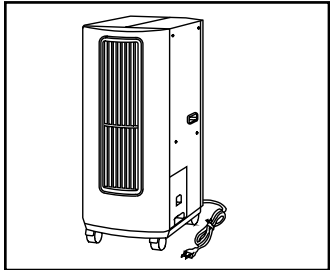

1. Place unit on a solid, level surface. Operating this unit on uneven or soft surfaces may cause vibration, noise, and possible water leakage from the condensate tank.

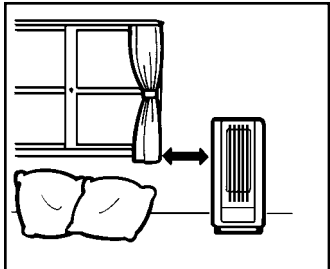

2. Place unit at least 20" from any walls, draperies, or other obstructions. Carefully push the unit on its caster wheels to desired location.

CAUTION: Do not operate unit without condensate water tank and air filters properly in place.

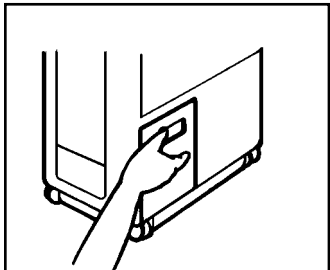

3. Check that condensate water tank is properly installed. When properly installed, the door of the condensate water tank will be flush with the exterior of the unit.

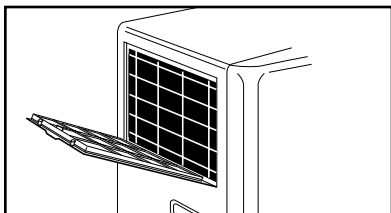

4. Check that air filter is clean and properly installed.

OPERATION

CAUTION: To avoid damage and voiding your warranty, place unit in its upright position for a minimum of two hours before operating. **DO NOT** operate unit without condensate water tank and air filter properly in place.

Cooling

This unit is intended to cool a 200-400 square foot area. The unit's cooling capacity will vary according to room temperature and humidity. Consult your Freecom dealer for specific application and suitability.

1. Plug power cord into a standard household outlet. Use this product only with the proper electrical voltage. See "SPECIFICATIONS" on previous page.

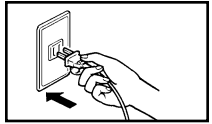

WARNING: Do not plug this appliance into an outlet that is being used by other appliances or electrical devices. When installing the electrical plug into the outlet, never touch or bend the metal prongs and always push plug into outlet by using the molded plug. Never use the electrical plug to start or stop the unit and avoid pulling, folding, or stretching the electrical cord.

2. Press "POWER ON/OFF" button on control panel. The unit will power up and air will begin blowing from the front louvers.

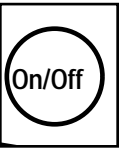

NOTE: This unit is equipped with a special safety time delay feature. The compressor (cooling mechanism) may be delayed for up to five minutes. This safety feature prevents damage to the compressor. The "COMP. ON" light will turn on while the compressor is running.

3. Press "MODE" button on control panel to choose "FAN," "HI," "ME," or "LO." The FAN setting is for air circulation only and does not provide any cooling. To change from a cooling mode to fan mode, press "POWER ON/OFF" button to turn unit off. Press "POWER ON/OFF" button again and immediately press "MODE" button to FAN setting.

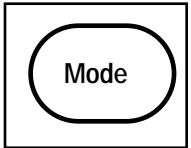

4. Press either "THERMO CONTROL" button to control a colder or cooler setting. The default temperature is 75°F. Press left button (COLD) to desired colder setting; right button (COOL) to desired cooler setting. Each press of the button will adjust the temperature approximately 3.5°F.

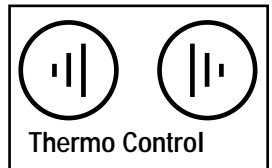

CAUTION: To avoid injury or damage and voiding the warranty, **DO NOT** manually adjust the vertical louvers.

5. Adjust horizontal louvers (up or down) as desired by moving the louver handles up or down. The top louver handle controls the top half of the horizontal louvers; the lower louver handle controls the bottom half of the horizontal louvers. **DO NOT** adjust horizontal louvers while vertical louvers are operating.

